

8 7 6 5 4 3 2 1

D

C

B

A

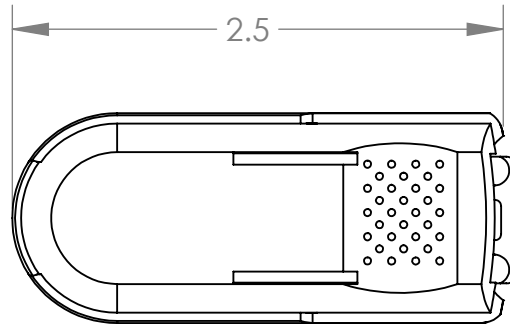
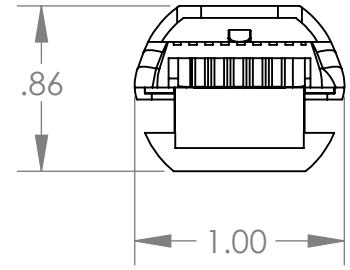
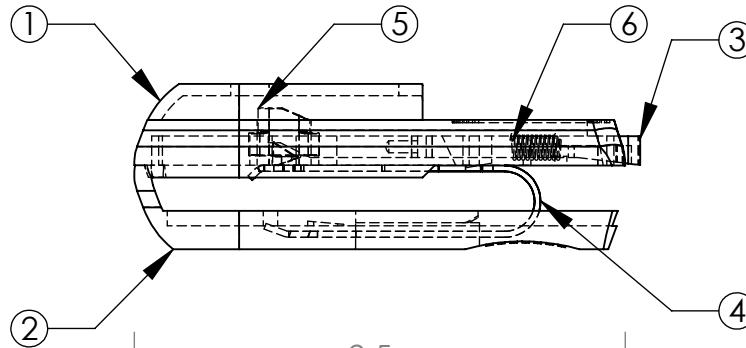
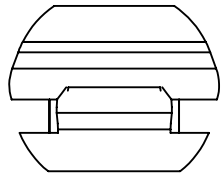
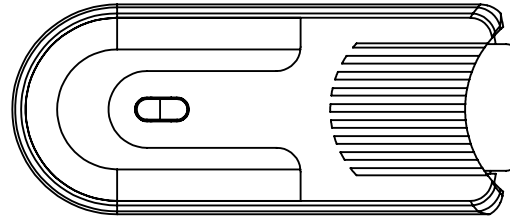
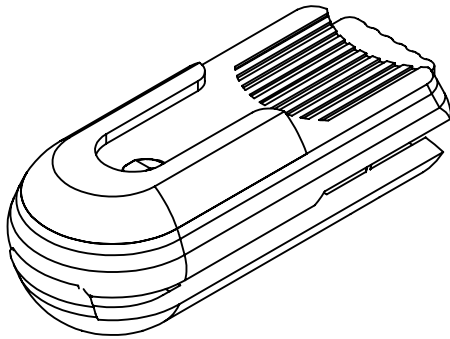

ITEM NO.	PART NUMBER	QTY.
1	764 TOP	1
2	764 BOTTOM	1
3	764 BUTTON	1
4	764 CLIP	1
5	764 lock	1
6	764 SPRING	1

MATERIAL	UNLESS OTHERWISE SPECIFIED DIMENSIONS ARE IN INCHES. TOLERANCES ARE:		 Device Portability Experts
	FRACTION +/- 1/64	DECIMAL .XX +/- .010 .XXX +/- .005	
FINISH	APPROVED	DATE	SIZE 764 BELT CLIP
	DRAWN D. E. STEIN	10/12/2016	
SIMILAR TO	CHECKED D. E. STEIN	10/24/2016	SCALE 1:1
			SHEET 1 OF 1

8 7 6 5 4 3 2 1